



A



ANKARA ÜNİVERSİTESİ

YABANCI UYRUKLU ÖĞRENCİ SINAVI (AYÖS) TEMEL ÖĞRENME BECERİLERİ TESTİ

20 Mayıs 2018

ADAYIN ADI VE SOYADI APPLICANT'S NAME SURNAME	:
ADAY NO APPLICANT'S NUMBER	:
SALON NO EXAMINATION ROOM NO	:
SIRA NO SEAT NUMBER	:

Adınızı, soyadınızı, aday numaranızı ve sınav salon numaranızı yukarıda boş bırakılan yere yazınız.
Write your name, surname, candidate number, and examination hall no in the appropriate places above.

GENEL AÇIKLAMA (GENERAL INSTRUCTIONS)

1. Bu sınavdaki soruların nasıl cevaplanacağı, testlerin başında açıklanmıştır. Soruları cevaplamaya başlamadan önce bu açıklamaları dikkatle okuyunuz.
2. Bu testlerdeki her sorunun bir tek doğru cevabı vardır. Bir soru için birden çok cevap yeri işaretlenmişse, o soru yanlış cevaplanmış sayılacaktır.
3. Cevaplarınızı koyu siyah ve yumuşak bir kurşun kalemle işaretleyiniz. İşaretlerinizi cevap yerinin dışına taşırmayınız. Tükenmez kalem veya dolma kalem kullanmayınız.
4. Cevap kâğıdınızı buruşturmayınız, katlamayınız ve üzerine gereksiz hiçbir işaret koymayınız.
5. Değiştirmek istediğiniz bir cevabı, yumuşak bir silgiyle, cevap kâğıdını örselemeden, temizce siliniz ve yeni cevabınızı işaretlemeyi unutmayınız.
6. Sınavda uyulacak diğer kurallar bu kitapçığın arka kapağında belirtilmiştir.

1. The instructions for answering the questions appear at the beginning of the tests. Please read these carefully before beginning.
2. In these tests there is only one correct answer for each question. If more than one alternative is marked, that answer will automatically be considered wrong.
3. You should use a soft, black pencil to mark the answer sheet. Completely fill in the circle for the answer you have chosen, but make sure your mark does not exceed of the circle. Do not use any kind of pen.
4. Keep the answer sheet flat and do not fold it. Do not make any unnecessary marks on it.
5. If you wish to change an answer, carefully erase it completely with a soft eraser. Do not forget to mark your new answer.
6. The other regulations concerning the administration of the tests will be found at the back of the booklet.

.....



B



ANKARA ÜNİVERSİTESİ

YABANCI UYRUKLU ÖĞRENCİ SINAVI (AYÖS)

TEMEL ÖĞRENME BECERİLERİ TESTİ

20 Mayıs 2018

ADAYIN ADI VE SOYADI APPLICANT'S NAME SURNAME	:
ADAY NO APPLICANT'S NUMBER	:
SALON NO EXAMINATION ROOM NO	:
SIRA NO SEAT NUMBER	:

Adınızı, soyadınızı, aday numaranızı ve sınav salon numaranızı yukarıda boş bırakılan yere yazınız.
Write your name, surname, candidate number, and examination hall no in the appropriate places above.

GENEL AÇIKLAMA (GENERAL INSTRUCTIONS)

1. Bu sınavdaki soruların nasıl cevaplanacağı, testlerin başında açıklanmıştır. Soruları cevaplamaya başlamadan önce bu açıklamaları dikkatle okuyunuz.
2. Bu testlerdeki her sorunun bir tek doğru cevabı vardır. Bir soru için birden çok cevap yeri işaretlenmişse, o soru yanlış cevaplanmış sayılacaktır.
3. Cevaplarınızı koyu siyah ve yumuşak bir kurşun kalemle işaretleyiniz. İşaretlerinizi cevap yerinin dışına taşırmayınız. Tükenmez kalem veya dolma kalem kullanmayınız.
4. Cevap kâğıdınızı buruşturmayınız, katlamayınız ve üzerine gereksiz hiçbir işaret koymayınız.
5. Değiştirmek istediğiniz bir cevabı, yumuşak bir silgiyle, cevap kâğıdını örselemeden, temizce siliniz ve yeni cevabınızı işaretlemeyi unutmayınız.
6. Sınavda uyulacak diğer kurallar bu kitapçığın arka kapağında belirtilmiştir.

1. The instructions for answering the questions appear at the beginning of the tests. Please read these carefully before beginning.
2. In these tests there is only one correct answer for each question. If more than one alternative is marked, that answer will automatically be considered wrong.
3. You should use a soft, black pencil to mark the answer sheet. Completely fill in the circle for the answer you have chosen, but make sure your mark does not exceed of the circle. Do not use any kind of pen.
4. Keep the answer sheet flat and do not fold it. Do not make any unnecessary marks on it.
5. If you wish to change an answer, carefully erase it completely with a soft eraser. Do not forget to mark your new answer.
6. The other regulations concerning the administration of the tests will be found at the back of the booklet.

.....

1 – 4 sorularını aşağıdaki örneğe göre çözünüz

örnek:

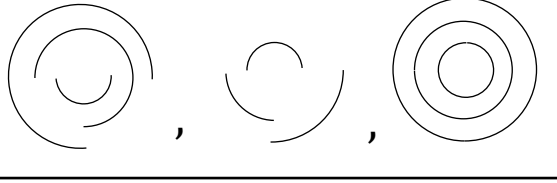

2.

1.

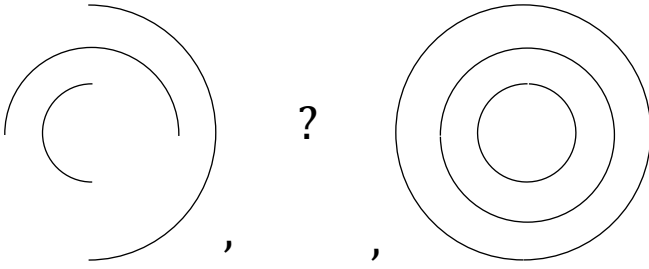

A)

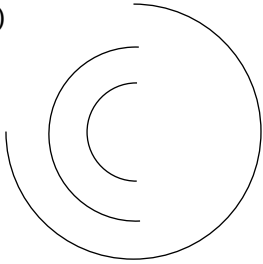

B)

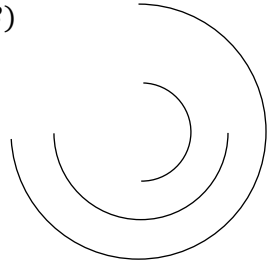

C)

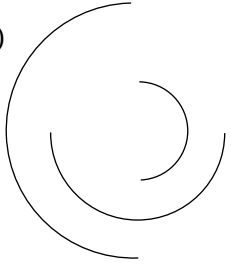

D)

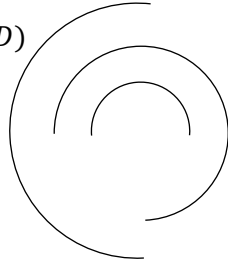

E)

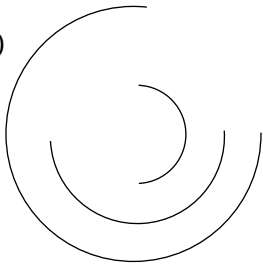

3.

5 – 8 sorularını aşağıdaki örneğe göre çözünüz

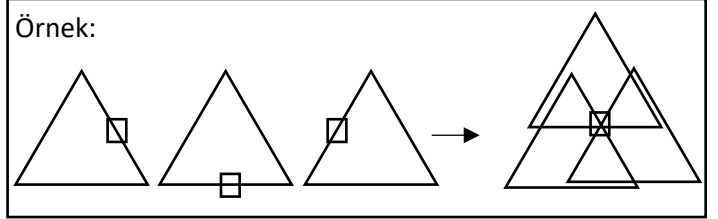

4.

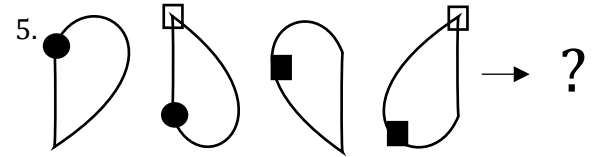

- A)
- B)
- C)
- D)
- E)

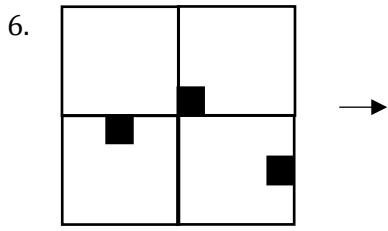

A)

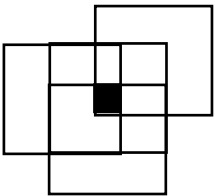

B)

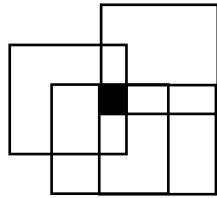

C)

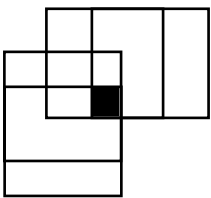

D)

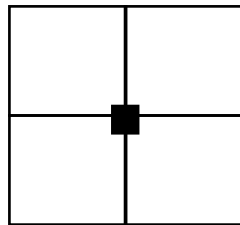

E)

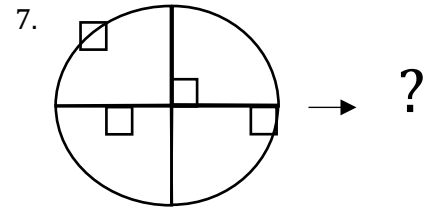
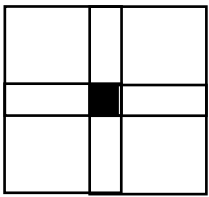

A)

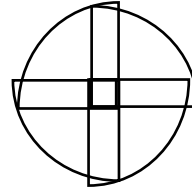

B)

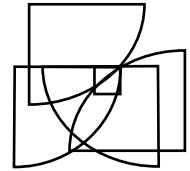

C)

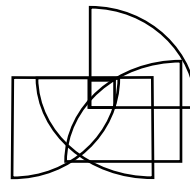

D)

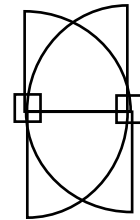

E)

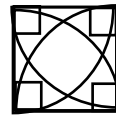

8.

9 – 12 sorularını aşağıdaki örneğe göre çözünüz

örnek:

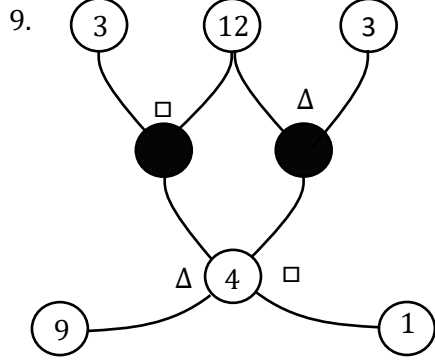
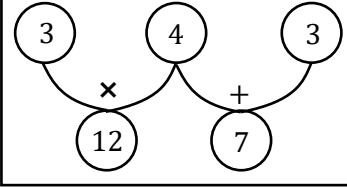

- Δ □
 A) + ÷
 B) ÷ ×
 C) ÷ +
 D) × ÷
 E) + ÷

10.

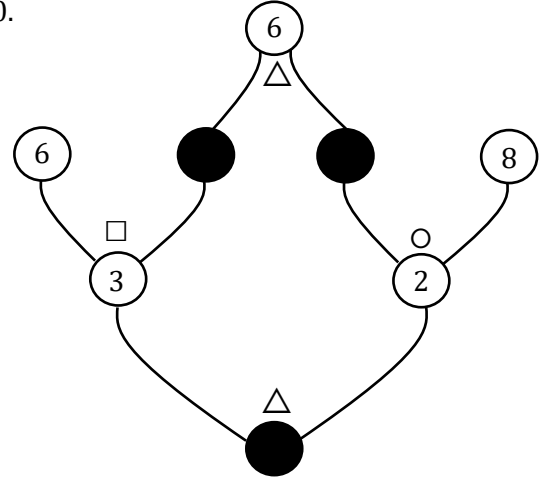

- Δ □ ○
 A) + ÷ ÷
 B) ÷ × ×
 C) ÷ + +
 D) × ÷ ÷
 E) + ÷ ÷

13 - 17 sorularını aşağıdaki tabloya göre çözünüz

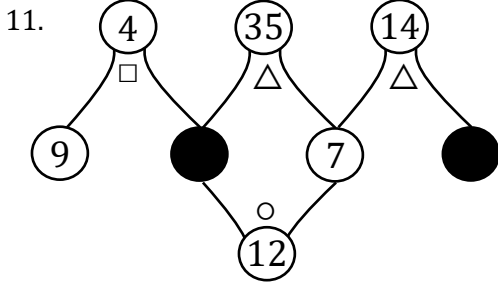

- Δ ○
 A) - × +
 B) + × -
 C) - + ×
 D) - × ÷
 E) - + +

I }
 II }
 III }
 IV }
 V }
 VI }

H	L	M	G
F	L	G	H
G	H	R	N
K	N	M	P
M	P	K	N
N	M	R	F

$$I(1) = II(4)$$

$$I(2) = II(2)$$

$$III(1) = VI(2)$$

$$IV(4) = VI(1)$$

12.

13. III(2) = ?

- A)H B)L C)M D)G E)P

14. IV(2) = ?

- A)H B)M C)N D)F E)R

15. V(2) = ?

- A)H B)P C)R D)N E)F

16. VI(4) = ?

- A)F B)R C)H D)N E)M

17 – 21 sorularını aşağıdaki verilen örneğe göre çözünüz

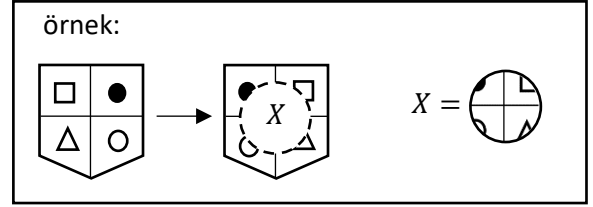

17.

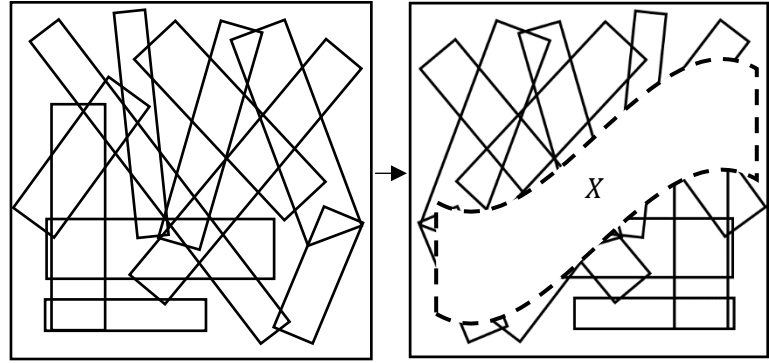

X = ?

- A) B) C) D) E)

18.

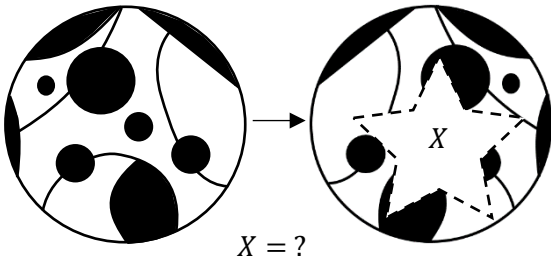

- A)
- B)
- C)
- D)
- E)

19.

20.

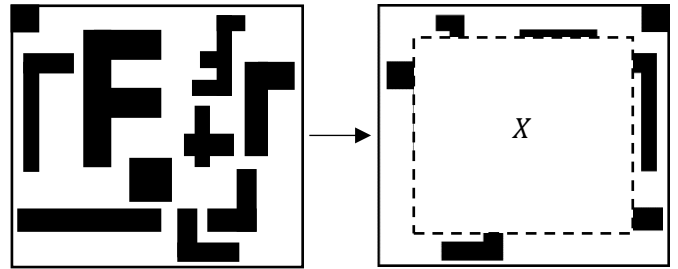

X = ?

- A)
- B)
- C)
- D)
- E)

21.

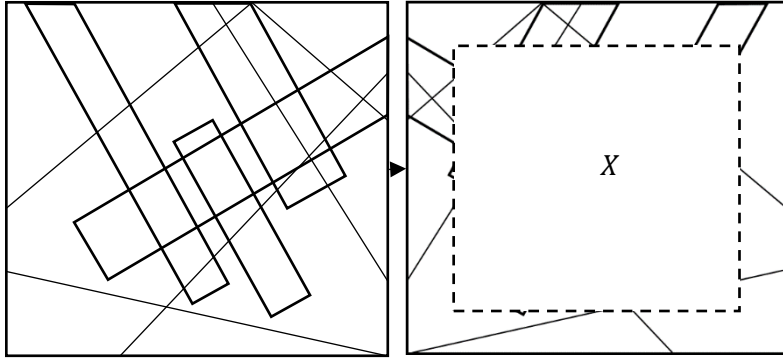

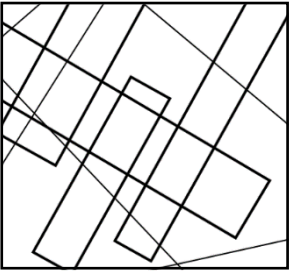
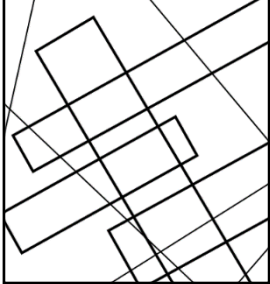
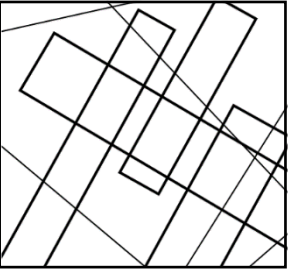
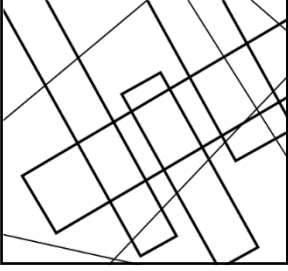
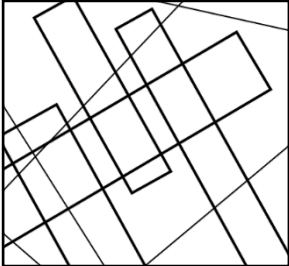

$X = ?$

- A) 
- B) 
- C) 
- D) 
- E) 

22 – 24 sorularında açık hali verilen küpün kapalı halini bulunuz

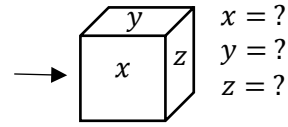
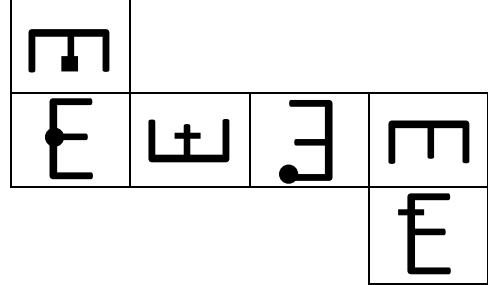
22.

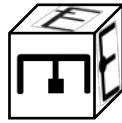
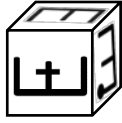

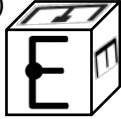
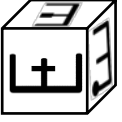
- A) 
- B) 
- C) 
- D) 
- E) 

23.

24.

25 – 30 sorularını aşağıdaki verilen örneğe göre çözüünüz

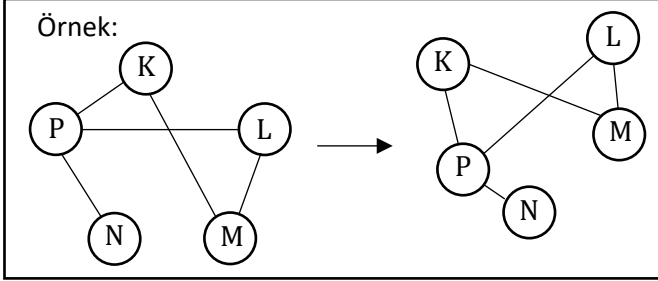

25.

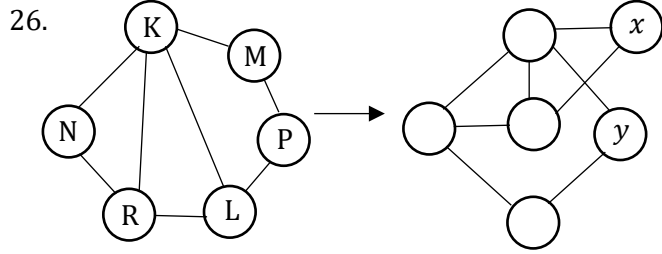

x y

- A) N P
 B) M K
 C) P M
 D) N M
 E) M P

27.

28.

29.

30.

31 – 36 sorularını aşağıdaki verilen örneğe göre çözüünüz

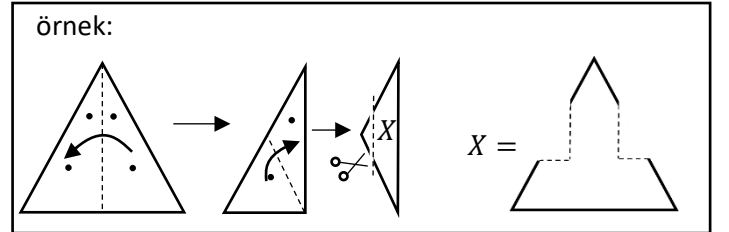

31.

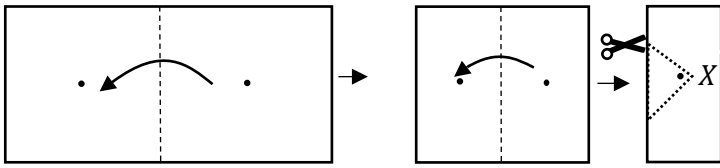

$X = ?$

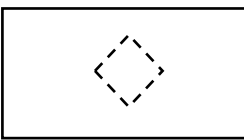
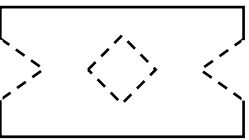
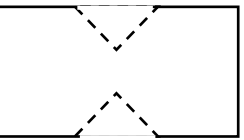
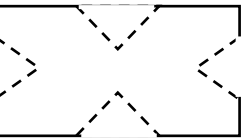
- A)  B) 
- C)  D) 
- E) 

32.

33.

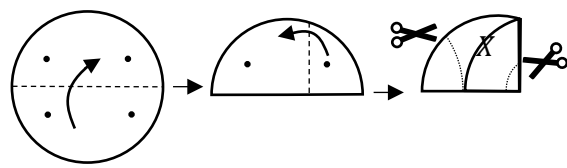

$X = ?$

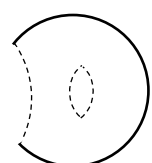
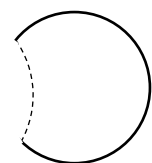
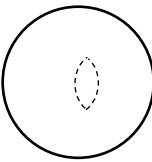
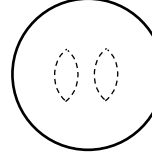
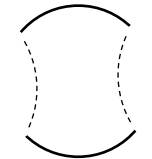
- A)  B) 
- C)  D) 
- E) 

34.

35.

37.

+	a	b	c
a			15
b			a+7
c	3a		

$\Rightarrow b = ?$

- A)1 B)2 C)3 D)4 E)5

36.

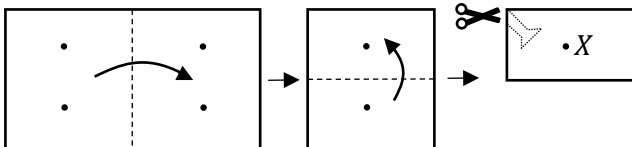

$X = ?$

- A)
- B)
- C)
- D)
- E)

38.

+	a	b	c
a			
b	5k	8k	9k
c	24		

$\Rightarrow b - a = ?$

- A)6 B)9 C)3 D)12 E)15

39.

x	a	b	c
a			9b
b	c		
c		4a	

$\Rightarrow a + b + c = ?$

- A)11 B)12 C)13 D)10 E)9

40.

x	a	b	c
a			18
b			27
c	6b		

$\Rightarrow a + b + c = ?$

- A)11 B)12 C)13 D)14 E)15

41 – 43 sourularını aşağıdaki verilen örneğe göre çözünüz

Örnek:

	a	b	c	d	e
		▲		■	
I	△	○	⬡	○	⬡
II	□	⬡	○	□	△
III	○	□	△	⬡	○

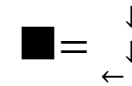
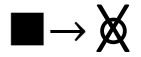
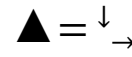
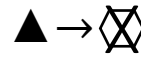

	a	b	c	d	e
I	△	○	▲	○	⬡
II	□	⬡	■	□▲	△
III	○	□	△	⬡	○▲

	a	b	c	d	e	f
I						
II						
III						
IV						
V						

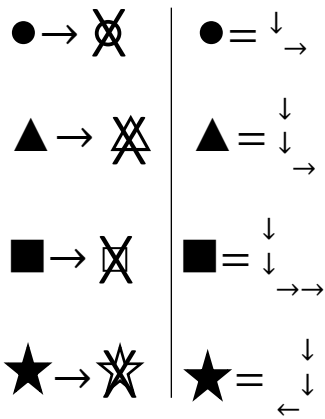

41. III b = ?

- A)
- B)
- C)
- D)
- E)

42. II d, IV e = ?

- A)
- B)
- C)
- D)
- E)

43.

I c IV f II e IV e

?	?	?	?
---	---	---	---

A)

△ ●	▲	☆	■
-----	---	---	---

B)

▲	△ ■	★	□
---	-----	---	---

C)

△ ●	▲ ●	★ ●	■
-----	-----	-----	---

D)

△ ●	▲	☆	☆ ■
-----	---	---	-----

E)

△	△	☆	□
---	---	---	---

44 – 49 sorularını aşağıdaki kurala göre çözünüz

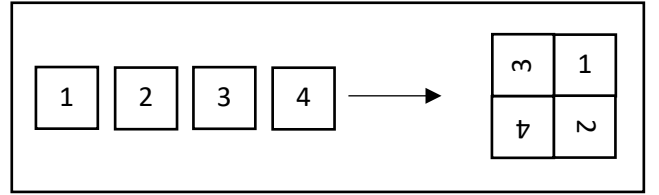

44.

45.

46.

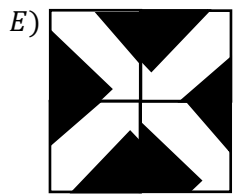
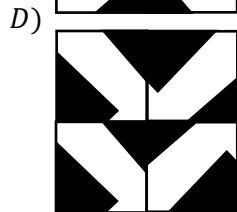
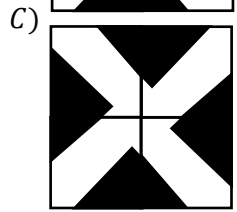
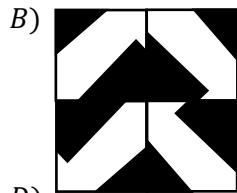
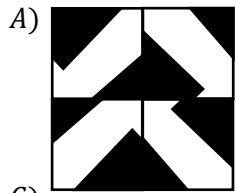

47.

48.

49.

50.

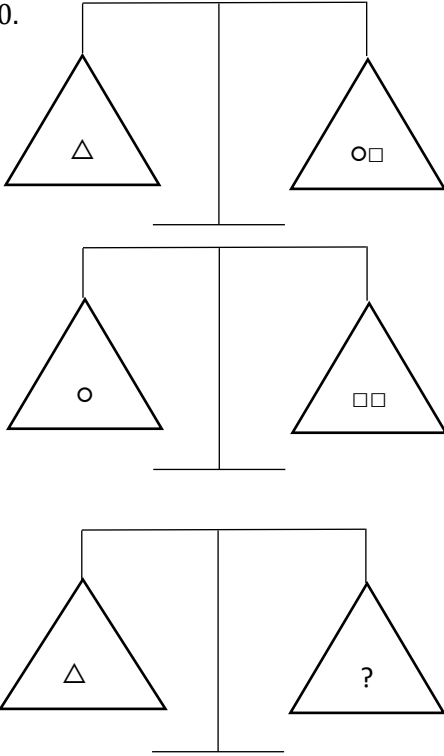

Yukarıdaki terazilerin tümü dengede olduğuna göre soru işareti yerine aşağıdakilerden hangisi gelmelidir?

- A) ○□ B) ○○ C) □□
 D) △△ E) △○

51.

52.

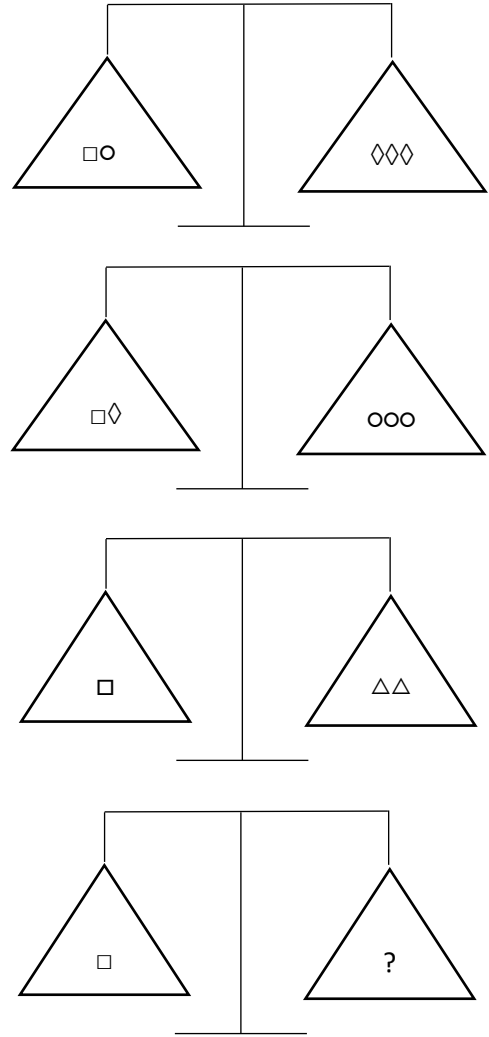

Yukarıdaki terazilerin tümü dengede olduğuna göre soru işareti yerine aşağıdakilerden hangisi gelmelidir?

- A) ◇◇○ B) ◇○△ C) ○△
 D) ◇△○ E) △△

53.

55 – 60 sorularda, soru işaretinin yerine getirilmesi gereken şekli bulunuz

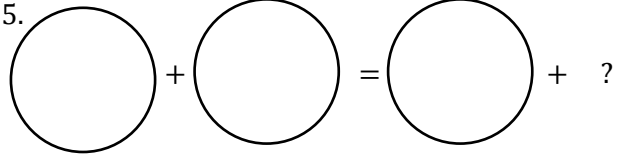
55. 

54.

56.

57.

59.

58.

60.

A

61. $-\frac{2}{3} - \frac{2}{7} + \frac{5}{3} = ?$

A) $\frac{5}{3}$ B) $\frac{4}{7}$ C) $\frac{5}{7}$ D) $\frac{2}{3}$ E) $\frac{16}{21}$

62. $\frac{6}{\sqrt{2}} - \frac{2}{\sqrt{2}-1} = ?$

A) $\sqrt{2} - 2$ B) $\sqrt{2} + 2$ C) $3\sqrt{2} + 2$
D) $\sqrt{2} + 4$ E) $3\sqrt{2} - 2$

63. $\sqrt{5} \cong 2,2$

$\sqrt{11} \cong 3,3$

$\Rightarrow \sqrt{44} - \frac{3\sqrt{5}}{\sqrt{11}} = ?$

A) 2 B) 3 C) 4 D) 4,3 E) 4,6

64. $|-x + 1| + 3x \leq 11$

$x \in \mathbb{N}$

$\Rightarrow \zeta.K = ?$

A) $0 \leq x \leq 3$ B) $1 \leq x \leq 4$ C) $1 \leq x \leq 5$

D) $3 \leq x \leq 4$ E) $3 \leq x \leq 5$

65. $\frac{x+1}{3} = \frac{y-1}{2} = \frac{z+1}{4}$

$x + y + z = 17$

$\Rightarrow \frac{z}{x+y} = ?$

A) 0,3 B) 0,4 C) 0,6 D) 0,7 E) 0,8

66. $\int 4 \cdot e^{2x-1} dx = ?$

A) $e^{2x+1} + c$

B) $2e^{2x+1} + c$

C) $e^{2x-1} + c$

D) $2e^{2x-1} + c$

E) $4e^{2x-1} + c$

67.

$$g(2x - 1) = x \cdot f(x) - 2$$

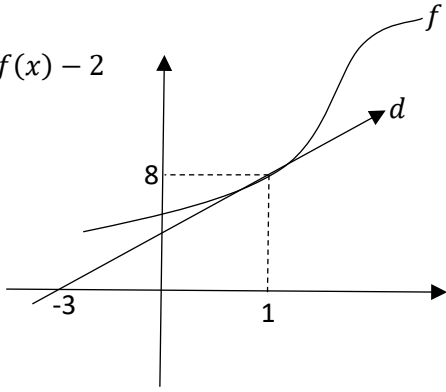

$$\Rightarrow g'(1) = ?$$

- A)10 B)8 C)7 D)5 E)4

68. $f(x) = x^2 - 1$

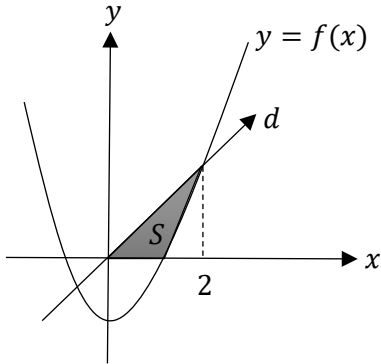

$$S = ?$$

- A) $\frac{11}{3}$ B) $\frac{7}{3}$ C) $\frac{5}{3}$ D) $\frac{4}{3}$ E) $\frac{10}{3}$

69. $\int_1^{e^2} \frac{3 \ln^2 x}{x} dx = ?$

- A)6 B)8 C)2e D)4e E)e

70. $f(x) = x^3 + ax^2 + bx + c$

$$f(0) = 1, f'(0) = 2, f''(0) = -4$$

$$\Rightarrow f(-1) = ?$$

- A) -5 B) -4 C) -3 D) -2 E) -1

71. $\left(\frac{1-i}{1+i}\right)^{20} = ?$

- A) -i B)1 C)i D) -1 E)1 - i

A

72. $\log_3 3^{2x-1} = x + 1$

$\Rightarrow x = ?$

A)1 B)2 C)3 D)4 E)5

73. $\log_2 a + \log_8 8a = \frac{11}{3}$

$\Rightarrow a = ?$

A)2 B)3 C)4 D)5 E)6

74. $3x + 2y = \frac{\pi}{2}$

$\Rightarrow \frac{\sin(4x + y)}{\cos(y - x)} = ?$

A)0 B)1 C) $\frac{\pi}{2}$ D) $\frac{\pi}{3}$ E) $\frac{\pi}{4}$

75. $A = 7! + 3^{17}$

$A = x \pmod{10}$

$\Rightarrow x = ?$

A)2 B)3 C)4 D)5 E)7

76. $P(x) = 3x^2 + kx + 1$

$P(x_1) = P(x_2) = 0$

$x_1 \neq x_2, x_1 + x_2 = 2x_1 \cdot x_2$

$\Rightarrow k = ?$

A) -3 B) -2 C) -1 D)1 E)2

77. $P(x) = 3x^3 - x + 8$

$P(x - 1) = x \cdot Q(x + 1)$

$\Rightarrow Q(3) = ?$

A)10 B)8 C)5 D)4 E)3

78. $x = 3 + \sqrt{y+1}$

$\Rightarrow \frac{dy}{dx} = ?$

- A) $x^2 - 6x + 2$ B) $2x + 6$ C) $2x + 4$
 D) $x - 6$ E) $2x - 6$

79. $(2a - 1)^3 \cdot 0,008 = 27$

$\Rightarrow a = ?$

- A)6 B)7 C)8 D)9 E)10

80. $a, b, c \in \mathbb{Z}^+$

$a - c = 9$

$b + 2c < 12$

$a_{\max} = ?$

- A)4 B)7 C)13 D)14 E)15

81. $m = 4^x, n = 6^x$

$\frac{1 - 2^x - 4^x + 8^x}{1 - 2^x - 6^x + 12^x} = ?$

- A) $\frac{m}{n}$ B) $\frac{1-n}{1-m}$ C) $\frac{m-1}{n-1}$ D) $\frac{m-1}{n}$ E) $\frac{m}{n-1}$

82. $A, B \subset U$

$(A' \cup B)' \cap A' = ?$

- A)A B)B C)U D) $A' \cap B$ E) \emptyset

83. $9^{a+1} \cdot 3^{-2a+b} = 81$

$\Rightarrow b = ?$

- A)1 B)2 C)3 D)4 E)5

84. $x - 3y + 4z - t = 8$

$x - 4y + 5z - t = 9$

$\Rightarrow x + z - t = ?$

- A)5 B)6 C)7 D)8 E)9

$$85. \frac{x^2 - x - 6}{2x^2 + 2x - 4} \cdot \frac{x^3 - x}{x^2 - 2x - 3} = \frac{5}{2}$$

$$\Rightarrow x = ?$$

A)2 B)3 C)4 D)5 E)6

$$86. f(x) = 3x + 1, g(x) = x^3 - 5$$

$$(g \circ f)^{-1}(3) = ?$$

A) $\frac{1}{2}$ B) $\frac{1}{6}$ C) $\frac{1}{3}$ D) $\frac{1}{12}$ E) $\frac{1}{8}$

$$87. f(x) = x + \sin x \cdot \cos x$$

$$f' \left(\frac{\pi}{4} \right) = ?$$

A)1 B)2 C)0 D) $1 + \sqrt{2}$ E) $1 + \frac{\sqrt{2}}{2}$

$$88. A(-1,4), B(2,1), C(0,3), D(k,0)$$

$$\overrightarrow{AB} \parallel \overrightarrow{CD}$$

$$\Rightarrow k = ?$$

A)0 B)4 C)3 D) -3 E) -4

$$89. d_1: ax + by + c = 0$$

$$d_2: x - 2y + 4 = 0$$

$$a + b = -6, d_1 \perp d_2$$

$$\Rightarrow a = ?$$

A) -2 B) -4 C) -6 D)2 E)4

90.

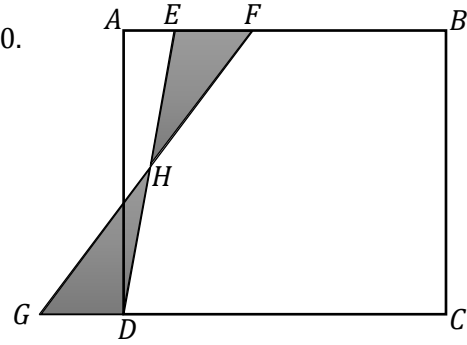

$$[AB] \perp [CD] \perp [DC] \perp [AD]$$

$$|AB| = |CD| = |DC| = |AD|$$

$$|AE| = |EF| = |FB|$$

$$|DC| = 3|GD|$$

$$A(GHD) + A(EFH) = 26 br^2$$

$$\Rightarrow A(ABCD) = ? br^2$$

A)52 B)156 C)178 D)104 E)154

91. $f(x) = \frac{x^2}{\sin x}$

$\Rightarrow f'(0^+) = ?$

- A) ∞ B)3 C)0 D)1 E)2

92.

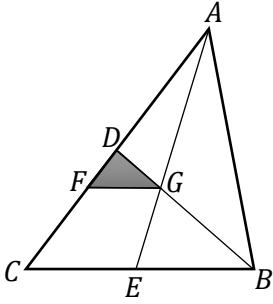

$|CD| = |AD|, |CE| = |EB|$

$FG \parallel CB, A(DGF) = 2 br^2$

$\Rightarrow A(ABC) = ? br^2$

- A)12 B)18 C)24 D)32 E)36

93.

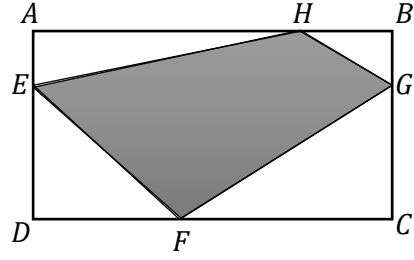

$[AB] \perp [BC] \perp [CD] \perp [AD]$

$|AB| = |CD|, |AE| = |BG|$

$A(EFGH) = 12 br^2$

$\Rightarrow A(ABCD) = ? br^2$

- A)16 B)24 C)36 D)48 E)32

94.

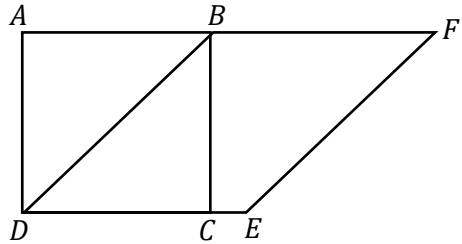

$[AB] \perp [BC] \perp [CD] \perp [DA]$

$|AB| = |BC| = |CD| = |DA|$

$|DB| = |BF| = |FE| = |ED|$

$A(ABCD) = 16 br^2$

$\Rightarrow A(BFED) = ?$

- A) $16\sqrt{2}$ B)16 C) $12\sqrt{2}$ D)12 E) $8\sqrt{2}$

95.

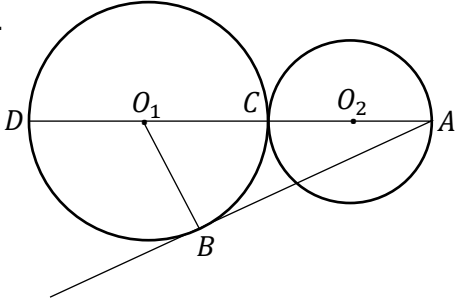

$$[O_1B] \perp [AB], |AO_2| = |CO_2| = r$$

$$|CO_1| = |DO_1| = 2r$$

$$|AB| = 12br$$

$$\Rightarrow r = ?br$$

$$A)12 \quad B)4\sqrt{3} \quad C)3\sqrt{2} \quad D)2\sqrt{3} \quad E)1$$

96.

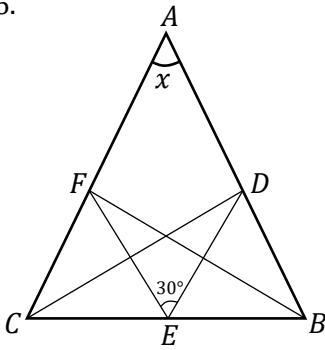

$$[BF] \perp [AC], [CD] \perp [AB]$$

$$m(\widehat{FÊD}) = 30^\circ$$

$$|CE| = |EB|$$

$$\Rightarrow m(\widehat{CÂB}) = x = ?$$

$$A)35 \quad B)45 \quad C)60 \quad D)65 \quad E)75$$

97.

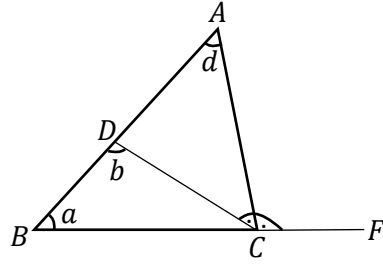

$$m(\widehat{DÊA}) = m(\widehat{AÊF})$$

$$b - a = 70^\circ$$

$$d = ?$$

$$A)25^\circ \quad B)30^\circ \quad C)35^\circ \quad D)40^\circ \quad E)45^\circ$$

98.

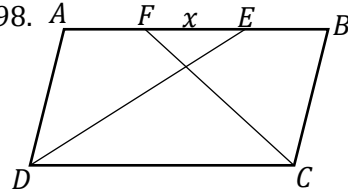

ABCD paralelkenar

$$m(\widehat{AÊE}) = m(\widehat{EÊC})$$

$$m(\widehat{BÊF}) = m(\widehat{FÊD})$$

$$|AD| = 18, |DC| = 24$$

$$|FE| = x = ?$$

$$A)4 \quad B)6 \quad C)8 \quad D)12 \quad E)16$$

99.

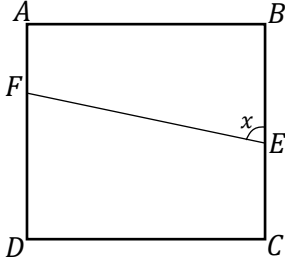

$ABCD$ kare

$$2|AF| = |FD|, |BE| = |EC|$$

$$m(\widehat{FEB}) = x$$

$$\Rightarrow \tan x = ?$$

A)2 B)3 C)4 D)5 E)6

100.

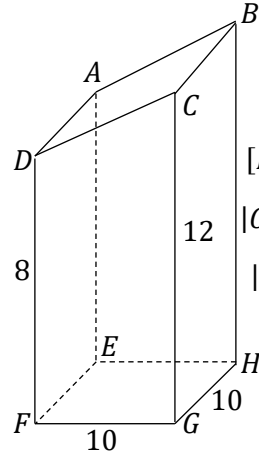

$$[DF] \perp [FG], [FG] \perp [GC]$$

$$[HG] \perp [FG], [HE] \perp [AE]$$

$$|GH| = 10 \text{ br}, |CG| = 12 \text{ br}$$

$$|FG| = 10 \text{ br}, |DF| = 8 \text{ br}$$

$$\Rightarrow V(ABCDEFGH) = ? \text{ br}^3$$

A)729 B)960 C)810 D)1000 E)1080

A

AYÖS 2019 deneme

1. C
2. -
3. -
4. -
5. A
6. A
7. C
8. -
9. B
10. A
11. A
12. -
13. E
14. B
15. D
16. A
17. A
18. D
19. -
20. E
21. A
22. E
23. -
24. -
25. -
26. D
27. -
28. -
29. -
30. -
31. C
32. -

33. A
34. -
35. -
36. E
37. B
38. D
39. A
40. D
41. A
42. E
43. C
44. -
45. -
46. C
47. -
48. -
49. -
50. B
51. -
52. C
53. -
54. -
55. -
56. -
57. -
58. -
59. -
60. -
61. C
62. A
63. E
64. A
65. D
66. D

67. D
68. B
69. A
70. B
71. B
72. B
73. C
74. B
75. B
76. B
77. C
78. E
79. C
80. D
81. C
82. E
83. B
84. A
85. D
86. C
87. A
88. C
89. B
90. Y
91. -
92. E
93. B
94. A
95. D
96. E
97. C
98. D
99. E
100. D

RULES FOR THE CONDUCT OF THE EXAMINATION

- 1. No materials or electronic devices shall be brought into the room or used at an examination.** Unauthorized materials include, but are not limited to: books, dictionaries, class notes, or aid sheets, weapons, explosive materials. Unauthorized electronic devices include, but are not limited to: cellular (mobile) telephones, laptop computers, calculators, MP3 players (such as an Ipad), Personal Digital Assistants ("PDA" such as a Palm Pilot or Blackberry), pagers, electronic dictionaries, Compact Disc Players, Mini Disc Players, Smart Watches and Smart Glasses. Anyone who violate these rules will be penalized by invalidating their exam results.
- 2. AYÖS Exam duration: 120 minutes.**
- 3.** No candidate who has submitted their question paper to those supervising the examination and have left the test room, for any reason whatsoever, will be allowed to re-enter the room.
- 4.** Candidates will NOT be permitted to enter an examination room later than first thirteen (30) minutes after the commencement of the examination, nor to leave until at least half an hour after the examination has commenced. Candidates shall remain seated at their desks during the final fifteen (15) minutes of the examination. Students who arrive following the first 30 minutes after the examination has started will NOT be allowed in the test rooms.
- 5.** Candidates shall not communicate with one another in any manner whatsoever during the examination. During the test, it is forbidden to ask questions of or talk to those supervising the exam. It is also against the rules of the examination for supervisors to converse or whisper to any candidates. Similarly, it is forbidden to ask another candidate for a pencil, eraser, or anything else.
- 6.** During the examination, candidates are required to comply with all the directions given to them by the supervisors; they also have the authority to assign seats to candidates. You must follow all instructions given to you. Otherwise, your name and application number will be taken, and your examination will be invalidated.
- 7.** If, during the test anyone is found cheating, trying to cheat, or helping someone else to cheat, his/her name and application number will be recorded, and his/her answer sheet will not be considered for evaluation. Supervisors do not have to warn candidate(s) about their act of cheating. This is the candidates' responsibility. During the examination, it is extremely important that you take utmost attention for not letting your answer sheet be seen by another candidate.
- 8.** It is important to fill in the necessary areas on the answer sheet. You must use only a soft lead pencil for writing your name and other information or marking answers. No type of pen may be used. Mark your answers only on the answer sheet. For each question mark one letter (A, B, C, D, or E) on your answer sheet. Answers marked only in the question books will be ignored.
- 9.** Do not open the question book until you are told to do so. After required you should check throughout your question book and make sure that no pages are missing and all pages are readable. You should inform the supervisors immediately in such an event so that your test booklet can be changed. Check whether the letter printed at the top of each page in the question book is the same as the letter printed on the cover. If you realize such a disparity later in the exam, you should ask those supervisors in charge for a new question book that matches with the type you have been working on up to that time. Remember to mark the type of the question book on your answer sheet; otherwise, your exam will be invalid, since it will not be possible to evaluate it.
- 10.** You may use the blank spaces on the pages of the question book as scrap paper for writing or calculating purposes.
- 11.** No one, including supervisors in charge, is allowed to smoke a cigarette, or any other tobacco products during the examination.
- 12.** It is strictly forbidden to make a record of your answers on any paper and take it out.
- 13.** At the end of the examination, hand in both the question book and the answer sheet. Question books and other material issued for the examination shall not be removed from the examination room.
- 14.** The correct and the incorrect answers that you will give to the questions in the booklet will be counted, And your raw score will be calculated after every four incorrect answers will cancel one correct answer.

SINAVDA UYULACAK KURALLAR

- 1. Cep telefonu ile sınava girmek kesinlikle yasaktır.** Çağrı cihazı, telsiz, vb. haberleşme araçları ile cep bilgisayarı, saat fonksiyonu dışında fonksiyonu bulunan saat vb. her türlü bilgisayar özelliği bulunan cihazlarla ve ayrıca silah vb. teçhizatla, müsvedde kâğıdı, defter, kitap, sözlük, sözlük işlevi olan elektronik aygıt, hesap makinesi, hesap cetveli, hesap defteri, açılış, cetvel vb. araçlarla sınava girmek yasaktır. Araçlarla sınava girmiş adayların yabancı uyruk numaraları mutlaka Salon Sınav Tutanağına yazılacak, bu adayların sınavları geçersiz sayılacaktır.
- 2. Sınav süresi 120 dakikadır.**
- 3. Sınav sırasında herhangi bir nedenle dışarı çıkmak yasaktır.** Sınavın başlamasını izleyen ilk 30 dakika ve sınav süresinin son 15 dakikası içinde, sınavlarını tamamlasalar bile hiçbir adayın salondan çıkmasına izin verilmeyecektir. Sınavın başlamasını izleyen ilk 30 dakikadan sonra hiçbir aday sınava alınmaz..
- 4. Sınav evrakını teslim ederek salonu terk eden aday, her ne sebeple olursa olsun tekrar sınava alınmayacaktır.**
- 5. Sınav süresince görevlilerle konuşmak ve onlara soru sormak yasaktır.** Aynı şekilde görevlilerin de adaylarla yakından ve alçak sesle konuşmaları; ayrıca, adayların birbirinden kalem, silgi vb. şeyleri istemeleri kesinlikle yasaktır.
- 6. Sınav sırasında görevlilerin her türlü uyarılarına uymak zorundasınız.** Gerektiğinde görevliler oturduğunuz yerleri de değiştirebilir. Sınavınızın geçerli sayılması, her şeyden önce sınav kurallarına uymanıza bağlıdır. Kurallara aykırı davranışta bulunur ve yapılacak uyarılara uymazsanız kimliğiniz tutanağa yazılacak ve sınavınız geçersiz sayılacaktır.
- 7. Sınav sırasında kopya çeken, çekmeye girişen, kopya veren, kopya çekilmesine yardım edenlerin kimlik bilgileri Salon Sınav Tutanağına yazılacaktır.** Adayların sınavları geçersiz sayılacaktır. Görevliler kopya çekmeye veya veremeyen adayları uyarmak zorunda değildir. Sorumluluk size aittir. Sınav sırasında cevap kâğıdınızı başkaları tarafından görülmeyecek şekilde tutmanız sizin için son derece önemlidir.
- 8. Cevap kâğıdında ilgili alanları doldurmanız gerekmektedir.** Cevap kâğıdına yazılacak her türlü yazıda ve yapılacak bütün işaretlemelerde kurşun kalem kullanılacaktır. Tükenmez kalem ve dolma kalem kesinlikle kullanılmayacaktır. Cevapların cevap kâğıdına işaretlenmiş olması gerekir. Soru kitapçığına işaretlenen cevaplar geçerli değildir.
- 9. Soru kitapçığınızı alır almaz, sayfaların eksik olup olmadığını, kitapçıkta basım hatalarının bulunup bulunmadığını kontrol ediniz.** Soru kitapçığının sayfası eksik veya basımı hatalı ise değiştirilmesi için derhâl Salon Başkanına başvurunuz. Soru kitapçığında her sayfanın tepesinde basılı bulunan soru kitapçığı türünün, kitapçığın ön kapağında basılı soru kitapçığı türüyle aynı olup olmadığını kontrol ediniz. Farklı olması durumunda Salon Başkanından yeni bir soru kitapçığı isteyiniz. Soru kitapçığının türünün değişik olduğunu daha sonra fark ederseniz, size o zamana kadar yapılmış soru kitapçığına göre, hatasız bir soru kitapçığı verilmesi için Salon Başkanına başvurunuz. Cevap kâğıdınıza, size verilecek olan soru kitapçığının türünü işaretlemeyi unutmayınız. Bu işaret konmamışsa sınavınızın değerlendirilmesine olanak bulunmadığından sınavınız geçersiz sayılacaktır.
- 10. Soru kitapçığının sayfalarındaki boş yerleri müsvedde için kullanabilirsiniz.**
- 11. Sınav sırasında, görevliler dahil, kimse sigara, pipo, puro vb. şeyleri içmeyecektir.**
- 12. Soruları ve bu sorulara verdiğiniz cevapları ayrı bir kâğıda yazıp bu kâğıdı dışarı çıkarmanız kesinlikle yasaktır.**
- 13. Sınav salonundan ayrılmadan önce, soru kitapçığınızı, cevap kâğıdınızı salon görevlilerine teslim etmeyi unutmayınız.**
- 14. testte yer alan sorulara vereceğiniz doğru ve yanlış cevapları sayılacak; doğru cevap sayısından yanlış cevap sayısının dörtte biri çıkarılarak (dört yanlışın bir doğruyu götürmesi) ham puanlarınız hesaplanacaktır.**